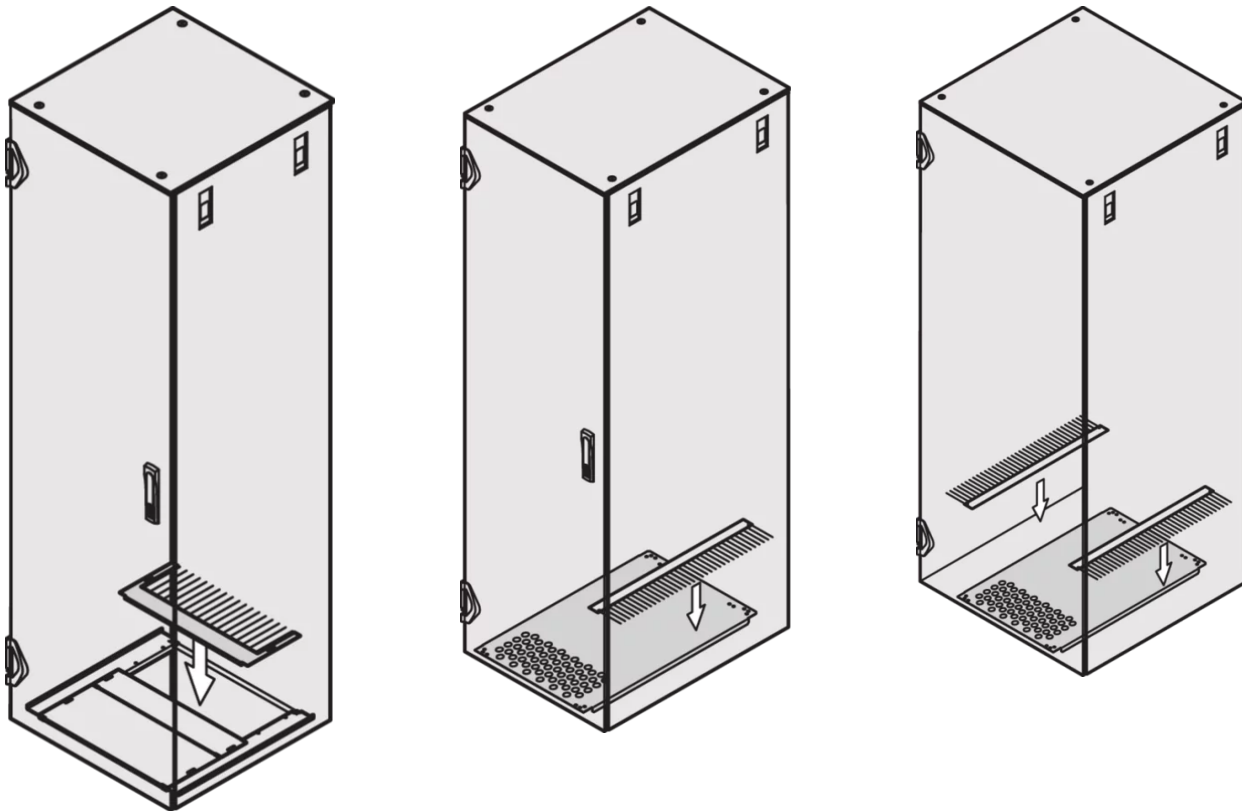

23130-134 VARISTAR BRUSH STRIP FOR BASE PLATE, 800W/D

**KEY FEATURES**

Cut-outs for cable entry in the base plate can be finished aesthetically by installing the brush strip

PRODUCT ATTRIBUTES

Product Type: Brush Strip

Product Family: Varistar

Works With: Base Plate

Color: Black

Width: 200 mm

ADDITIONAL PRODUCT DETAILS

Multi Piece Brush strip to close side opening of base plate (for side cable routing); 1-brush strip for various breadths.

CERTIFICATIONS



North America

All locations
+1.763.422.2661
Chat with us:
schroff.nvent.com

Europe

Straubenhardt, Germany
+49.7082.794.0
Betschdorf, France
+33.3.88.90.64.90
Warsaw, Poland
+48.22.209.98.35
Assago, Italy
+39.02.932.7141
Chat with us:
schroff.nvent.com

Asia

Shanghai, China
+86.21.2412.6943
Qingdao, China
+86.532.8771.6101
Singapore
+65.6768.5800
Shin-Yokohama, Japan
+81.45.476.0271
Chat with us:
schroff.nvent.com

Middle East & India

Dubai, United Arab Emirates
+971.4.378.1700
Bangalore, India
+91.80.6715.2001
Istanbul, Turkey
+90.216.250.7374
Chat with us:
schroff.nvent.com



Our powerful portfolio of brands:
nVent.com **CADDY ERICO HOFFMAN RAYCHEM SCHROFF TRACER**

© 2023 nVent. All nVent marks and logos are owned or licensed by nVent Services GmbH or its affiliates. All other trademarks are the property of their respective owners.

nVent reserves the right to change specifications without notice.