



Technical Specifications

MOBOTIX Q71

Hemispherical 360° imaging technology at its best

360° camera technology - compact, complete and versatile. The MOBOTIX Q71 sees everything and always. Its 360° optics are everywhere. For the first time, IR and LED white light are combined in one hemispherical camera. So you can even make the night colorful! 12 megapixels and WDR provide brilliant image quality and impressive details. The integrated audio function makes you heard. Embedded in the MOBOTIX 7 platform with its intelligent apps, the comprehensive video system offers you an infinite range of analysis options.

- 4K effective resolution: 12MP 2880x2880 (original hemispherical image)
- Integrated IR and white light LED spotlight
- Platform with the most flexible codec support: H.264, H.265, MxPEG+ and MJPEG
- ONVIF Profile S and T conformity guarantees utmost interoperability
- Wide Dynamic Range (WDR) with up to 120 dB
- Easy Plug quick-mounting system
- Robust in any environment: -40 to 65 °C/-40 to 149 °F, IP66, and IK10 (with optional accessory)



Technical Specifications

MOBOTIX Q71

Order Information

Name	Q71 Single Lens
Order Code:	Mx-Q71A-12DN016

Hardware

Image sensor (DN)	12MP effective max. resolution 2880x2880
Light sensitivity	<ul style="list-style-type: none">▪ Color sensor (day): 0,1 lx @ 1/60 s; 0,005 lx @ 1 s▪ BW sensor (night): 0,02 lx @ 1/60 s; 0,001 lx @ 1 s
Exposure control	Manual and automatic mode 1 s to 1/16,000 s
Video codecs	H.264, H.265 with Triple Streaming MxPEG+ MJPEG
IK protection class	IK10 (with optional accessory)
IP protection class	IP66
Ambient temperature (range, including housing)	-40 to 65 °C/-40 to 149 °F/95 % rel. humidity (non-condensing)
Internal DVR, out of the box	MicroSD card (8 GB), MxPEG+ recording only

I/Os	<p>INPUT</p> <ul style="list-style-type: none"> ▪ Contact Closure (no galvanic isolation necessary) or up to 50V AC/DC ▪ max. length for cables: 50m <p>OUTPUT</p> <ul style="list-style-type: none"> ▪ requires pull-up resistor and external power supply (10mA / max. 50V DC - no AC) ▪ max. length for cables: depends on loop impedance of the connected cable. <p>Specs for cables connected to the PCB terminals:</p> <p><i>Conductor cross section</i></p> <table border="1"> <tr> <td>AWG</td> <td>20 - 26</td> </tr> <tr> <td>Rigid</td> <td>0.14mm² - 0.5mm²</td> </tr> <tr> <td>Flexible</td> <td>0.14mm² - 0.5mm²</td> </tr> <tr> <td>Flexible with ferrule</td> <td>0.25mm² - 0.34mm²</td> </tr> </table>	AWG	20 - 26	Rigid	0.14mm ² - 0.5mm ²	Flexible	0.14mm ² - 0.5mm ²	Flexible with ferrule	0.25mm ² - 0.34mm ²
AWG	20 - 26								
Rigid	0.14mm ² - 0.5mm ²								
Flexible	0.14mm ² - 0.5mm ²								
Flexible with ferrule	0.25mm ² - 0.34mm ²								
Microphone/Speaker	<p>Integrated Microphone:</p> <ul style="list-style-type: none"> ▪ Sensitivity: -35 +-4 dB (0 dB = 1 V/pa, 1 kHz) <p>Integrated Loudspeaker:</p> <ul style="list-style-type: none"> ▪ 0.9 W at 8 Ohm <p>Line in / Line out</p>								
Integrated illumination	IR and White Light up to 15 m								
Shock detector (tamper detection)	Yes								
Max. power consumption	25 W								
Electrical surge protection	Available with MX-Overvoltage-Protection-Box (not part of the scope of delivery)								
PoE standard	PoE Plus (802.3at-2009)/Class 4								
Interfaces	<ul style="list-style-type: none"> ▪ Ethernet 1000BaseT; RJ45 jack according to EIA/TIA-568B ▪ USB-C / USB2.0; High-Speed ($V_{out} = 5,1V$, $I_{out} = 0,9A$, $P_{out} = 4,5W$) 								
Mounting Options	Wall- or ceiling-mountable								

Technical Specifications

MOBOTIX Q71

Dimensions
(Ø x height) 164 x 47,5 mm

Weight without sensor modules- Approx. 2.5 kg/5.5 lb

Housing Aluminum, PBT-30GF

Standard accessories

- 1 I/O dome, white
- 2 terminal blocks
- 1 mounting cable with sealing, 0.5 m/~2 in
- 2 silicone sealings for patch cable
- 1 Ethernet patch cable RJ45, 50 cm/19.7 in
- 1 Allen wrench 2.5 mm
- 1 Q71 lens wrench, blue
- 4 dowels 8 mm
- 4 stainless steel pan head-screws 4.5x60 mm
- 4 stainless steel washers Ø5.3 mm
- 1 Torx wrench TX 20
- 4 sealing plugs, white
- 1 Important Safety Information
- 1 Camera Connection Flyer

Detailed technical documentation www.mobotix.com > [Support](#) > [Download Center](#) > [Marketing & Documentation](#)

MTBF 80,000 hours

Certificates EN 50121-4:2015, EN 50581:2012, EN 55032:2012+AC:2013, EN 55035:2017, FprEN 61000-6-1:2015, EN 61000-6-2:2015, EN 61000-6-3:2007+A1:2011+AC:2012, EN 61000-6-4:2007+A1:2011, EN 62368-1:2014 + AC: 2015 + A11: 2017 + AC: 2017, IEC 60950-22:2016, AS/NZS CISPR32:2015, 47 CFR Part 15b

Protocols DHCP (client and server), DNS, ICMP, IGMP v3, IPv4, IPv6, HTTP, HTTPS, FTP, FTPS, NFS, NTP (client and server), RTP, RTCP, RTSP, SFTP, SIP (client and server), SMB/CIFS, SNMP, SMTP, SSL/TLS 1.3, UDP, VLAN, VPN, Zeroconf/mDNS

Manufacturer warranty 3 years

Image Formats, Frame Rates, Image Storage

Available video codecs	MxPEG+/MJPEG/H.264/H.265
Image resolutions	VGA 640x360, XGA 1024x576, HD 1280x720, FullHD 1920x1080, 4MP 2688x1512, 12MP 2880x2880
H.264 multi streaming	Triple Streaming
Multicast stream via RTSP	Yes
Max. image resolution	12MP 2880x2880 hemispheric image
Max. frame rate	MxPEG: 20@4k, H.264: 30@4k, H.265: 30@4k

General Features

WDR	Up to 120 dB
Software features	<ul style="list-style-type: none"> ▪ H.264, H.265 Multistreaming ▪ Multicast stream via RTSP ▪ Digital pan, tilt, zoom/vPTZ (up to 8x zoom) ▪ Genetec protocol integration ▪ Custom exposure zones ▪ Snapshot recording (pre/post-alarm images) ▪ Continuous recording ▪ Event recording ▪ Time-controlled flexible event logic ▪ Weekly schedules for recordings and actions ▪ Event video and image transfer via FTP and email ▪ Playback and QuadView via web browser ▪ Animated logos on the image ▪ Master/Slave functionality ▪ Privacy zone scheduling ▪ Remote alarm notification (network message) ▪ Programming interface (HTTP-API) ▪ MOBOTIXMessageSystem
ONVIF compatibility	Profile S, T
Master/Slave functionality	Yes
Remote alarm notification	email, network message (HTTP/HTTPS), SNMP, MxMessageSystem

Technical Specifications

MOBOTIX Q71

DVR/storage management (MxPEG+ only)	Within the camera via microSD card, on external USB and NAS devices, different streams for live image and recording, MxFFS with buffered archive, pre- and post-alarm images, storage monitoring with error reporting
--------------------------------------	---

Camera and data security	User and group management , SSL connections, IP-based access control, IEEE 802.1X, intrusion detection, digital image signature
--------------------------	---

Video Analysis

Video motion detection	Yes
------------------------	-----

MxActivitySensor	Version 1.0, 2.1
------------------	------------------

ONVIF compatibility	Profile S, T
---------------------	--------------

MxAnalytics	Heatmap, people counting & object-based counting
-------------	--

MOBOTIX Certified Apps support	Yes (will be added with upcoming firmware releases)
--------------------------------	---

Video Management Software

MxManagementCenter	Yes (MxMC 2.2 and higher)
--------------------	---------------------------

www.mobotix.com > [Support](#) > [Download Center](#) > [Software Downloads](#)

MOBOTIX LIVE	Yes
--------------	-----

www.mobotix.com > [Support](#) > [Download Center](#) > [Software Downloads](#)

Q71 – Dimensions

NOTE! Download the drilling template from the section or on the MOBOTIX website: www.mobotix.com > Support > Download Center > Marketing & Documentation > Drilling Templates.

CAUTION! Always print or copy at 100% of the original size!

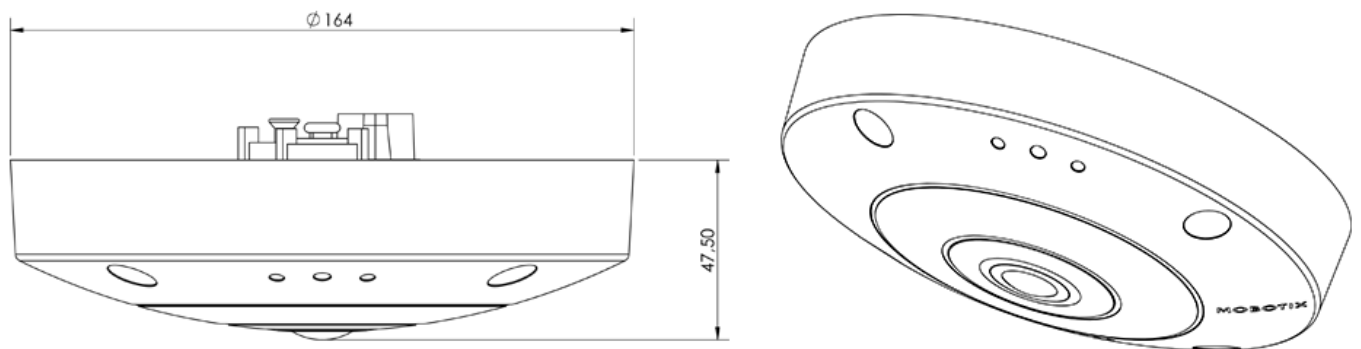

Fig. 1: Q71: All measurements in mm

MOBOTIX

BeyondHumanVision

[EN_11/21](#)

MOBOTIX AG • Kaiserstrasse • D-67722 Langmeil • Tel.: +49 6302 9816-103 • sales@mobotix.com • www.mobotix.com

MOBOTIX is a trademark of MOBOTIX AG registered in the European Union, the U.S.A., and in other countries. Subject to change without notice. MOBOTIX do not assume any liability for technical or editorial errors or omissions contained herein. All rights reserved. © MOBOTIX AG 2021